

STEEL DAVIT CRANE

Individually tested and certified at 125%



OZ1000DAV

**500 lbs., 1000 lbs.
and 2500 lbs. Capacity**

Features

- 360 degree rotation
- 4 different boom height adjustments
- 500, 1000, and 2500 lb. ratings available
- Manual Din rated CE winch with brake (Includes power drill adaptor)
- Zinc plated finish
- Headache Ball (OZHB10) available and sold separately
- Carrying case (OZRB1) available and sold separately

Weight	Boom	Mast	Net
OZ500DAV (lbs)	27	23	50
OZ1000DAV (lbs)	35	29	64
OZ2500DAV (lbs)	130	64	194

Load Ratings

*OZ500DAV based on 3/16" wire rope

*OZ1000DAV based on 1/4" wire rope

*OZ2500DAV based on 3/8" synthetic rope

	1st. Layer	Mid. Drum	Full Drum
OZ500DAV (lbs)	500	500	500
OZ1000DAV (lbs)	1000	875	550
OZ2500DAV (lbs)	2500	2000	1550

Steel Wire Rope (For manual winch)

OZGAL.19-80B	3/16" x 80'	Galvanized cable assembly
OZSS.19-80B	3/16" x 80'	Stainless steel cable assembly
OZGAL.25-55B	1/4" x 55'	Galvanized cable assembly
OZSS.25-55B	1/4" x 55'	Stainless steel cable assembly

All cable assemblies come with swaged ball and swivel hook with latch. **Custom cable length available.**
3/16" - 80 ft max. length • 1/4" - 55ft max. length

Steel Wire Rope (For manual and power winch)

OZGAL.19-90	3/16" x 90'	Galvanized cable assembly
OZSS.19-90	3/16" x 90'	Stainless Steel cable assembly
OZGAL.25-45	1/4" x 45'	Galvanized cable assembly
OZSS.25-45	1/4" x 45'	Stainless Steel cable assembly

All cable assemblies come with swaged ball and swivel hook with latch. **Custom cable length available.**
3/16" - 90 ft max. length • 1/4" - 45ft max. length

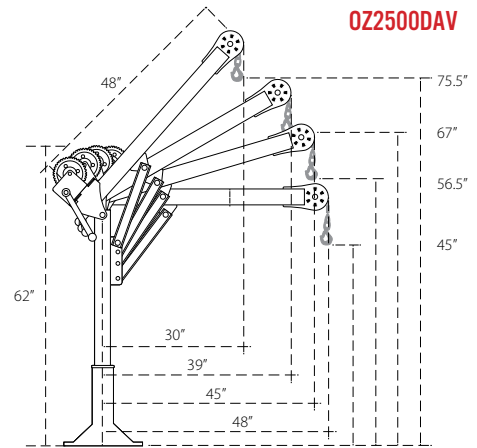
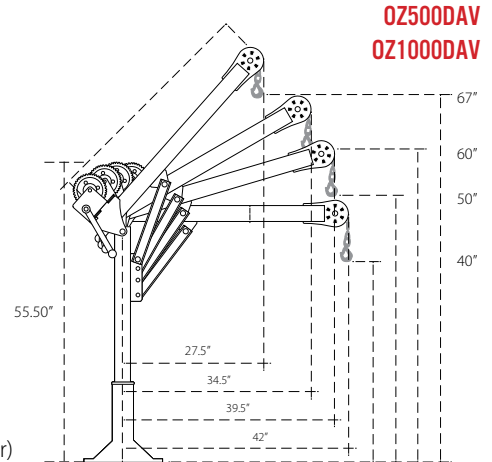

*Dimensions are for reference only and subject to change without notice.

OZPED2 base shown
Bases and cable assemblies sold separately



Options for faster lowering and raising

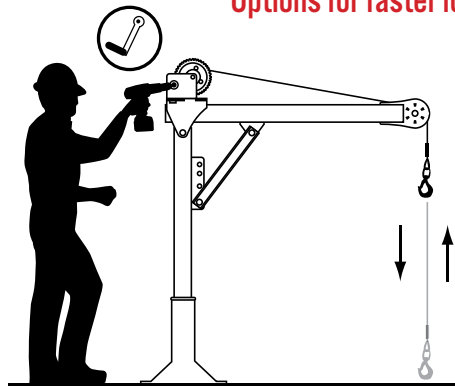

Detach winch handle for drill option.

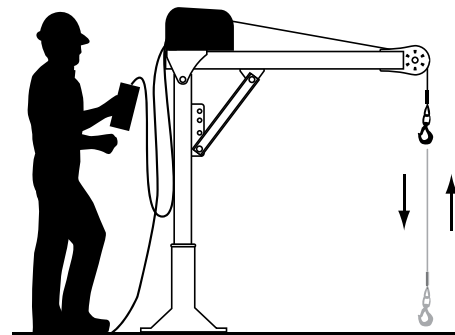

AC and DC power winches available.

DAVIT CRANE MOUNTING BASES (Sold Separately)

*Includes mounting template



STEEL DAVIT CRANE - OZ500DAV

OZPED3

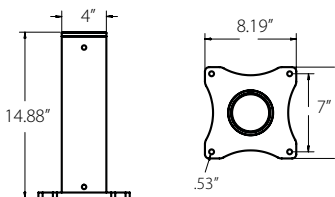

OZSOC3

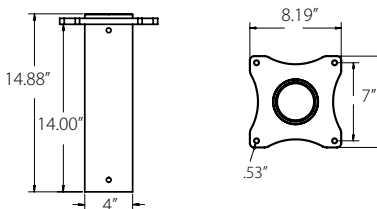

OZWALL3

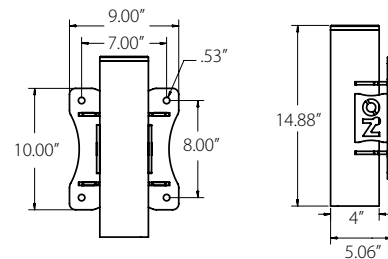

*Bases inside diameter 3.0"

STEEL DAVIT CRANE - OZ1000DAV

OZPED2

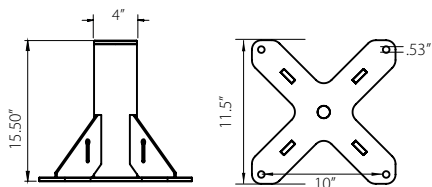

OZSOC2

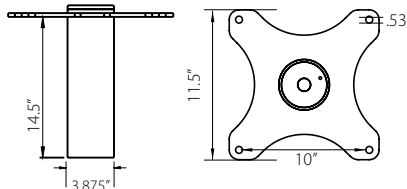

OZWALL2

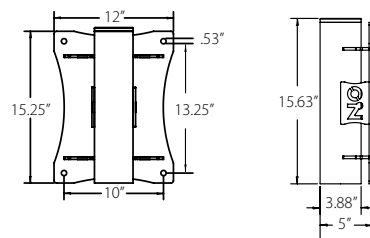

*Bases inside diameter 3.0"

STEEL DAVIT CRANE - OZ2500DAV

OZPED4

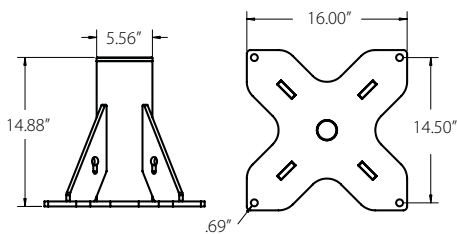

OZSOC4

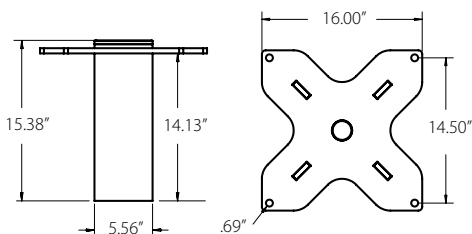

OZWALL4

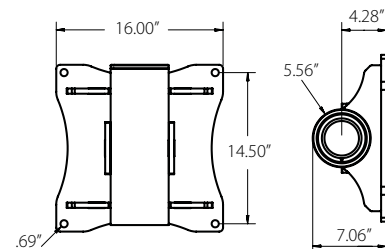

*Bases inside diameter 4.5"

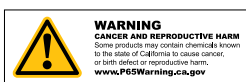



APPLICATION DATA SHEET | DAVIT CRANES

Date: _____

P.O. Box 845 Winona, MN 55987 • Tf: (800) 749-1064 • Ph: (507) 474-6250 • Fax: (507) 452-5217 • sales@ozliftingproducts.com

Company Name: _____ Contact Name: _____

Email Address: _____

Phone: _____ Fax: _____

Address: _____ City: _____ State: _____ Zip Code: _____

1. JOB DESCRIPTION:

2. WEIGHT OF LOAD:

3. HOW FAR IS THE LOAD MOVING?

4. REACH REQUIREMENTS:

5. WHAT CAPACITY DO YOU NEED AND WHAT REACH?

6. HEIGHT REQUIREMENTS:

7. WINCH REQUIREMENTS:

Hand 115 Volt AC 12 Volt DC

8. BASE REQUIREMENTS:

Pedestal Socket Wall Mount
 Base Extension

9. WHERE IS THE DAVIT CRANE BEING USED?

10. HOW DID YOU HEAR OF US?

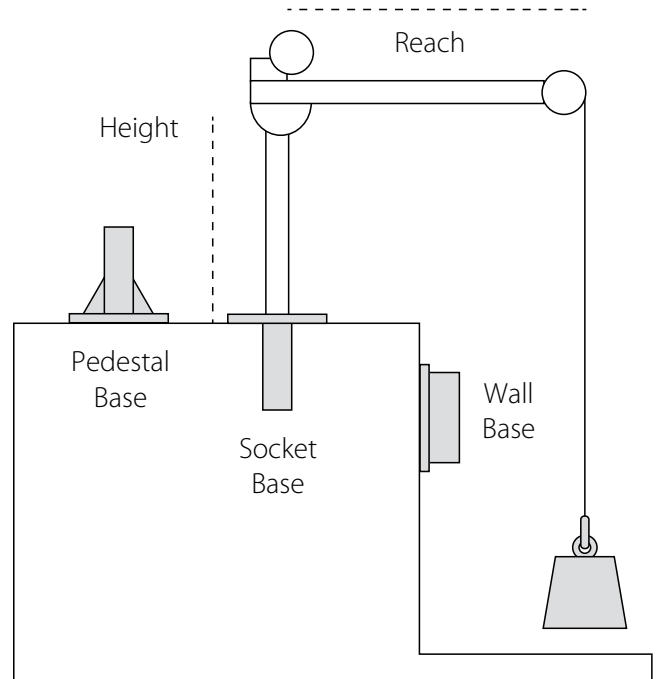

Purchaser is responsible for proper base installation. Consulting with a civil engineer or qualified professional is highly recommended.

Each crane is tested at 125%.
Test cert included. Cable and base sold separately.

OZ Lifting products are not for lifting up people or objects over people.

Load ratings may vary depending on position of boom, wire rope length and winch used.

