

COMPOZITE® DAVIT CRANE

Individually tested and certified at 125%



OZ1200DAV (PATENTED)



Boom Weight 43lbs. (excluding winch)

Crane weighs only 83 lbs. As Shown

Mast Weight 30lbs.

1200 lbs. Capacity Features

- **Boom/Extension and Mast Made of Advanced Composite Material**
- Light weight, about 40% lighter than steel
- Corrosion resistant
- Metal components mil-spec zinc plated
- External handle helps rotate crane under load
- 4 position boom
- Ratchet screw jack adjusts boom under load giving you infinite range of lift
- 360 degree rotation of crane on sleeve bearing
- No tools required for installation. One person setup.
- DIN-Rated hand winch equipped standard with a load holding weatherproof Weston brake (Cable assembly sold separately)
- Hand winch accepts two different cable termination points: swaged ball fitting or bare end cable
- Quick connect winch handle with power drill adapter included
- Smart Latch technology at boom/mast connection
- Headache Ball (OZHB10) available and sold separately. See page 34
- Carrying case (OZRB1) available and sold separately

OZ1200DAV shown with optional OZPED1 Pedestal base, OZSS.25-55B wire rope assembly, and OZHB10 headache ball
Bases, cable assemblies and headache ball sold separately

WIRE/SYNTHETIC ROPE ASSEMBLIES

(sold separately) Custom length available.

See wire/synthetic rope assembly options page 39

Manual winch: 3/16" - 80 ft max. lift length • 1/4" - 55ft max. lift length

AC/DC Electric Winch: 3/16" - 90 ft max. lift length • 1/4" - 45ft max. lift length

Options for faster lowering and raising

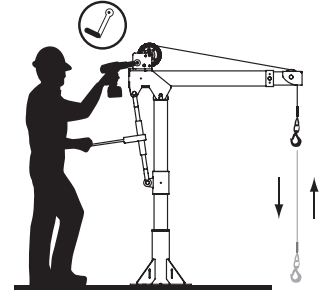

Detach winch handle for drill option

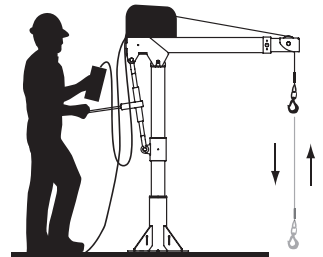

AC and DC power winches available
See page 26

**One person set up.
No tools required for installation.
Lightweight & Portable.**

Weight

Weight (excluding winch)	Boom	Mast	Net
OZ1200DAV (lbs)	43	30	73

OZ1200DAV BASES (sold separately) Comes with mounting template.

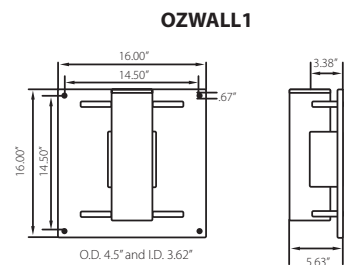
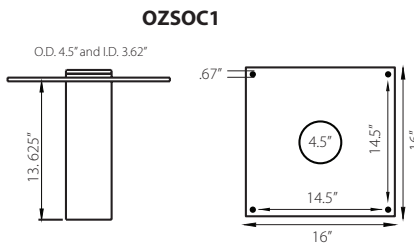
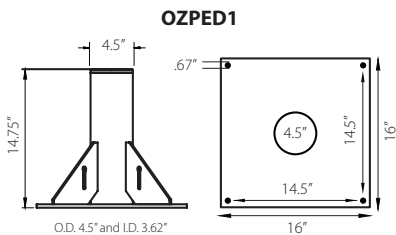

Dimensions and illustrations are for reference only and subject to change without notice.



OZ1200DAV DIMENSIONS Dimensions are for reference only and subject to change without notice.



w/ Socket Base

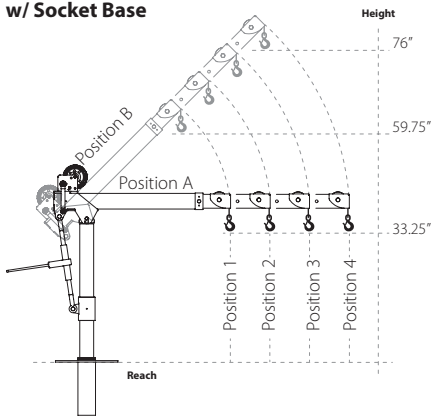

Boom Horizontal Position (A)

Boom Position 1: Reach 36"

Boom Position 2: Reach 46"

Boom Position 3: Reach 56"

Boom Position 4: Reach 66"

Boom 45° Position (B)

Boom Position 1: Reach 22"

Boom Position 2: Reach 29"

Boom Position 3: Reach 36"

Boom Position 4: Reach 43"

w/ Pedestal Base

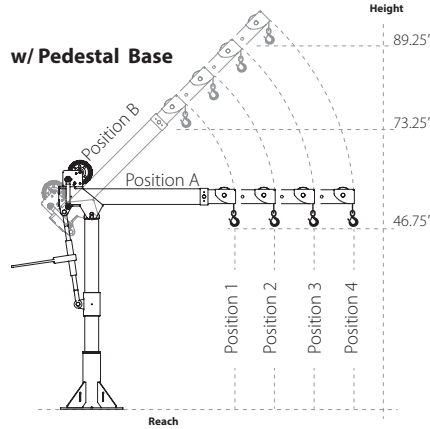

Boom Horizontal Position (A)

Boom Position 1: Reach 36"

Boom Position 2: Reach 46"

Boom Position 3: Reach 56"

Boom Position 4: Reach 66"

Boom 45° Position (B)

Boom Position 1: Reach 22"

Boom Position 2: Reach 29"

Boom Position 3: Reach 36"

Boom Position 4: Reach 43"

w/ Wall Mount Base

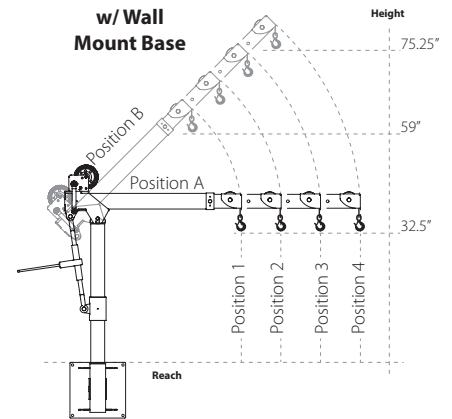

Boom Horizontal Position (A)

Boom Position 1: Reach 36"

Boom Position 2: Reach 46"

Boom Position 3: Reach 56"

Boom Position 4: Reach 66"

Boom 45° Position (B)

Boom Position 1: Reach 22"

Boom Position 2: Reach 29"

Boom Position 3: Reach 36"

Boom Position 4: Reach 43"

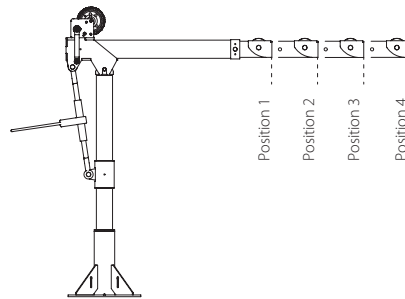

Load Ratings OZ1200DAV

*Table based on 1/4 inch wire rope or 3/16" Synthetic Rope

Load Ratings	First Layer	Mid Drum	Full Drum
Position 1 (lbs)	1200	875	550
Position 2 (lbs)	900	875	550
Position 3 (lbs)	700	700	550
Position 4 (lbs)	400	400	400

*Table based on 3/16" wire rope

Load Ratings	First Layer	Mid Drum	Full Drum
Position 1 (lbs)	800	800	550
Position 2 (lbs)	800	800	550
Position 3 (lbs)	700	700	550
Position 4 (lbs)	400	400	400

Designed for use in multiple workstations. Buy one crane and multiple bases.

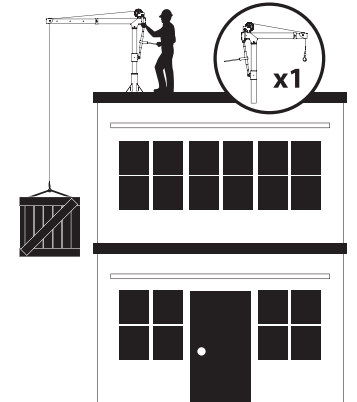

Make Your Truck More Versatile

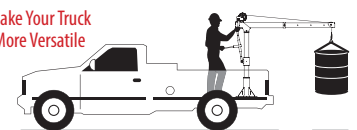

Great For Submersible Pump Installations

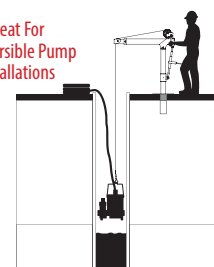

WHEEL BASE

For all OZ Lifting Products davit cranes up to 1200 lb. capacity



**OZWB3 shown with OZXR500
OZGAL.19-80B galvanized cable assembly
OZHB10 10lbs. headache ball**
Davit crane, headache ball, and cable assemblies sold separately.
Locking collar included with applicable wheel base kits.

Features

- Industrial strength steel construction with a durable powder-coat finish
- Patent-pending floor-anchoring system allows the davit to rotate while under load (when base is not anchored the davit must remain in a forward position when lifting)
- Durable polyurethane-tread indoor/outdoor wheels with rear swivel casters, ensuring smooth mobility and adaptability to various workspaces. Rear casters feature a lock brake for enhanced safety and stability when needed.
- Forklift pockets (for transporting only)

Includes

Floor-Anchor Mounting Bolt Kit: Enhance the stability and safety of your OZ Wheel Base with optional floor-anchoring bolts, ensuring secure attachment to the ground for added peace of mind during operation. Includes four (4) 12" zinc-plated hex head bolts and washers. *Concrete anchor not included.*

Davit Crane Locking Collar: This component effectively prevents the crane boom from rotating excessively, eliminating the risk of tipping hazards and ensuring a secure lifting environment. *Included with models OZWB1, OZWB1-TP, OZWB2, OZWB2-TP, and OZWB3.*

Toolbox Storage Tube: Keep your tools and Wheel Base accessories organized with this durable and versatile toolbox storage tube, molded from high-density polypropylene and featuring a secure screw-cap and latch closure for secure storage. Zip ties are included for convenient, versatile mounting.

**Davit crane sold separately*

- OZWB** Wheel Base for OZ Lifting Products davit cranes up to 1200 lbs. capacity (pedestal base and locking collar not included)
- OZWB1** Wheel Base for use with OZ1200DAV davit crane (pedestal base and locking collar included)
- OZWB1-TP** Wheel Base for use with OZTP1200DAV, OZA1000DAV, OZXR1000DAV davit cranes (pedestal base and locking collar included)
- OZWB2** Wheel Base for use with OZ1000DAV and OZCF1200DAV davit cranes (pedestal base and locking collar included)
- OZWB2-TP** Wheel Base for use with OZTP500DAV davit crane (pedestal base and locking collar included)
- OZWB3** Wheel Base for use with OZ500DAV, OZA500DAV and OZXR500DAV davit cranes (pedestal base and locking collar included)

Patent-Pending Floor-Anchoring System with Locking Collar



OZWB DIMENSIONS

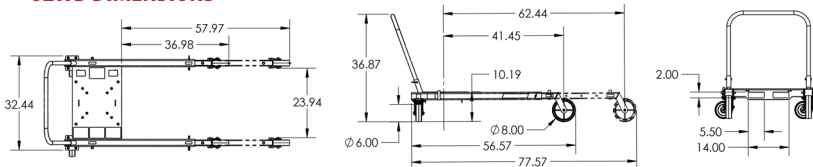

ADJUSTABLE LEG EXTENSIONS

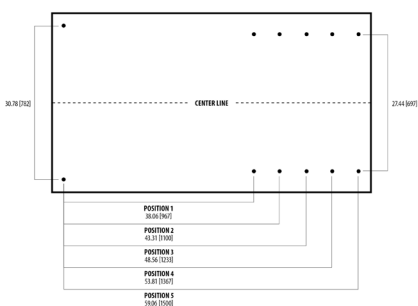

FLOOR-ANCHORING SYSTEM

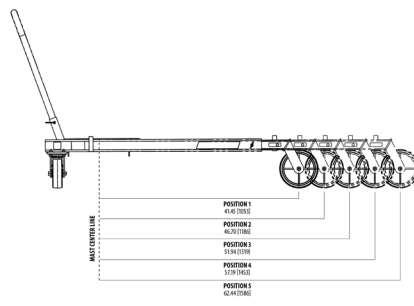

OZWB DAVIT CRANE REACH DIAMETER

Sections are representative of hook reach in 360-degrees

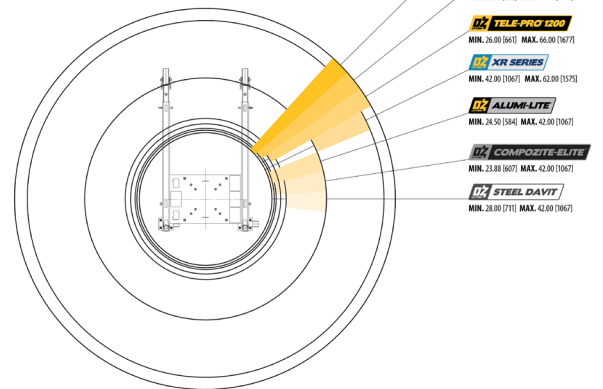

Diagram dimensional values are provided in inches. Bracketed values [] within diagram represent equivalent measurements in millimeters for informational purposes only. Dimensions and illustrations are for reference only and subject to change without notice.



WIRE/SYNTHETIC ROPE ASSEMBLIES

Steel Wire Rope (For manual winch)

OZGAL.19-80B	3/16" x 80'	Galvanized cable assembly
OZSS.19-80B	3/16" x 80'	Stainless steel cable assembly
OZGAL.25-55B	1/4" x 55'	Galvanized cable assembly
OZSS.25-55B	1/4" x 55'	Stainless steel cable assembly

Above cable assemblies come with swaged ball and swivel hook with latch.

Custom cable length available.

3/16" - 80 ft. max. length • 1/4" - 55 ft. max. length

Steel Wire Rope (For manual and power winch)

OZGAL.19-90	3/16" x 90'	Galvanized cable assembly
OZSS.19-90	3/16" x 90'	Stainless Steel cable assembly
OZGAL.25-45	1/4" x 45'	Galvanized cable assembly
OZSS.25-45	1/4" x 45'	Stainless Steel cable assembly

All cable assemblies come with a swivel hook with latch.

Custom cable length available.

3/16" - 90 ft. max. length • 1/4" - 45 ft. max. length



Synthetic Rope

OZSR.19-15	3/16" x 15'	Synthetic Rope
OZSR.19-50	3/16" x 50'	Synthetic Rope
OZSR.19-90	3/16" x 90'	Synthetic Rope
OZSR.25-50	1/4" x 50'	Synthetic Rope
OZSR.25-75	1/4" x 75'	Synthetic Rope
OZSR.31-45	5/16" x 45'	Synthetic Rope

All synthetic rope assemblies come with looped ends and pre-installed swivel hook with latch





HEADACHE BALL

OZHB10

Keeps your wire rope tensioned even when lowering the hook with no load. Compatible with 3/16" and 1/4" wire rope assemblies. Headache balls sold separately from all davit cranes and wire rope assemblies.



DAVIT CRANE COVER

OZDAV-C1

Protect your davit crane from the elements with this waterproof cover. Compatible with all OZ Lifting Products davit cranes 1200 lbs. capacity or less excluding the XR series.



DAVIT CRANE ROLLER BAG

OZRB1

Store and transport your davit crane in this davit crane roller bag. Fits OZ Lifting Products davit crane models OZ500DAV, OZ1000DAV, OZ1200DAV, OZCF1200DAV, OZA500DAV, & OZA1000DAV.

