

STEEL DAVIT CRANE

Individually tested and certified at 125% W.L.L



OZ500DAV, OZ1000DAV, OZ2500DAV



**500 lbs., 1000 lbs.
and 2500 lbs. Capacity**

Features

- 360 degree rotation
- 4 different boom height adjustments
- 500, 1000, and 2500 lb. ratings available
- Manual Din rated CE winch with brake (Includes power drill adapter)
- Corrosion Resistant Zinc plated finish
- Headache Ball (OZHB10) available and sold separately
- Carrying case (OZRB1) available and sold separately

OZ1000DAV shown with optional
OZPED2 Pedestal base and
OZGAL.25-55B wire rope assembly
Bases and cable assemblies sold separately

WIRE/SYNTHETIC ROPE ASSEMBLIES

(sold separately) Custom length available.

See wire/synthetic rope assembly options page 39

OZ500DAV & OZ1000DAV

Manual winch: 3/16" - 80 ft max. lift length • 1/4" - 55ft max. lift length

AC/DC Electric Winch: 3/16" - 90 ft max. lift length • 1/4" - 45ft max. lift length

OZ2500DAV

Manual winch: 1/4" Synthetic - 75 ft max. lift length • 5/16" Synthetic - 55ft

max. lift length • 3/8" Synthetic - 45ft max. lift length

Options for faster lowering and raising

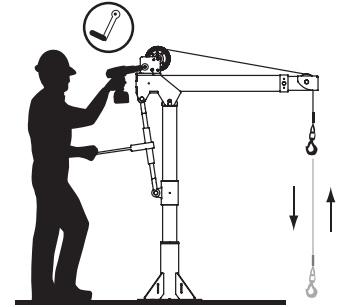

Detach winch handle for drill option

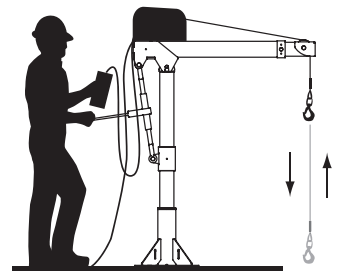

AC and DC power winches available
See page 26

OZ500DAV DIMENSIONS

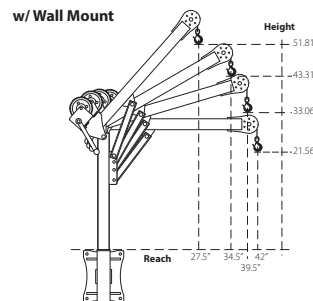
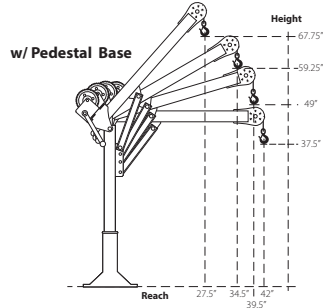
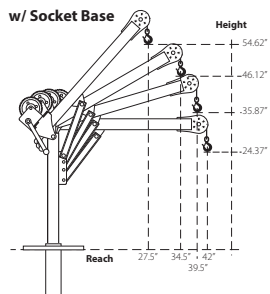

OZ500DAV BASES (sold separately) Comes with mounting template.

OZPED3

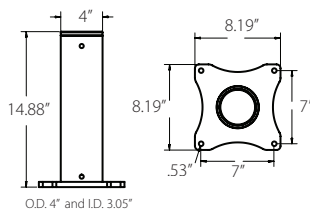

OZSOC3

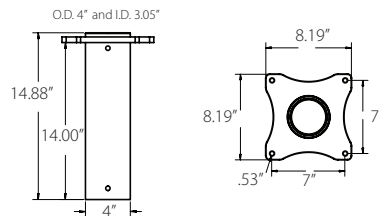

OZWALL3

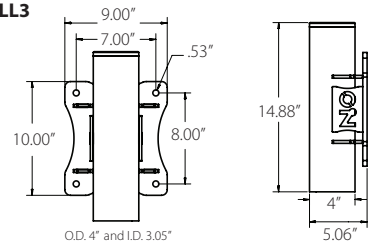

Weight

Weight (excluding winch)	Boom	Mast	Net
OZ500DAV (lbs)	27	23	50
OZ1000DAV (lbs)	35	29	64
OZ2500DAV (lbs)	130	64	194

Load Ratings

*OZ500DAV based on 3/16" or 5/16" wire & synthetic rope

First Layer	500 lbs
Mid Drum	500 lbs
Full Drum	500 lbs



Dimensions and illustrations are for reference only and subject to change without notice.



OZ1000DAV DIMENSIONS

w/ Socket Base

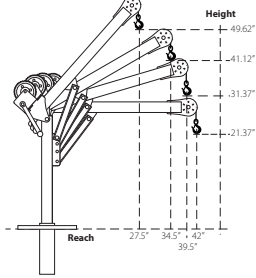

w/ Pedestal Base

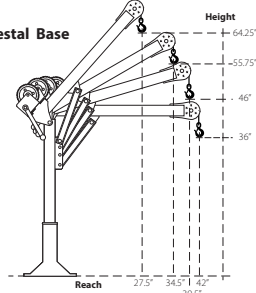

w/ Wall Mount

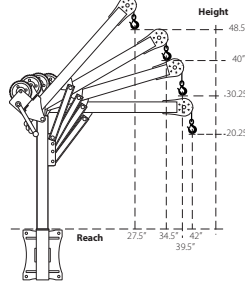

Load Ratings

*OZ1000DAV based on 1/4" wire & 3/16" synthetic rope

First Layer	1000 lbs
Mid Drum	875 lbs
Full Drum	550 lbs

OZ1000DAV BASES (sold separately) *Base inside diameter 3.0" • Comes with mounting template.

OZPED2

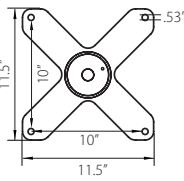
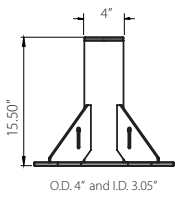

OZSOC2

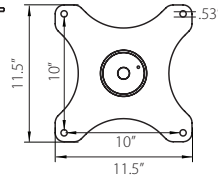
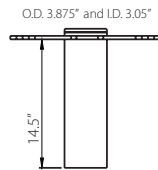

OZWALL2

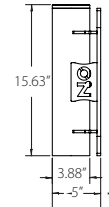
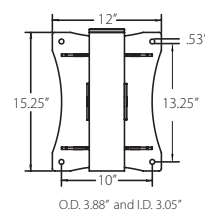

OZ2500DAV DIMENSIONS

w/ Socket Base

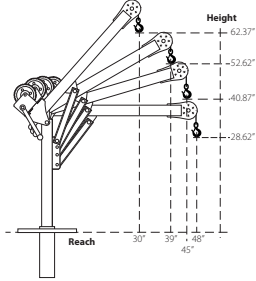

w/ Pedestal Base

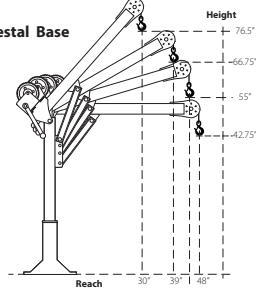

w/ Wall Mount

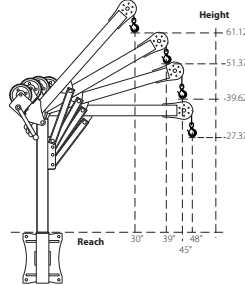

Load Ratings

*OZ2500DAV based on 3/8" synthetic rope

First Layer	2500 lbs
Mid Drum	2000 lbs
Full Drum	1550 lbs

OZ2500DAV BASES (sold separately) *Base inside diameter 4.5" • Comes with mounting template.

OZPED4

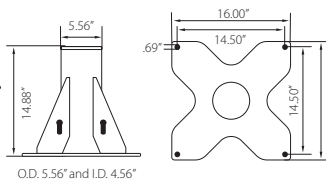

O.D. 5.56" and I.D. 4.56"

OZSOC4

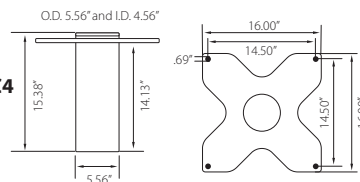

OZWALL4

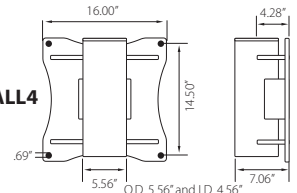

Dimensions and illustrations are for reference only and subject to change without notice.



WHEEL BASE

For all OZ Lifting Products davit cranes up to 1200 lb. capacity



OZWB3 shown with OZXR500
OZGAL.19-80B galvanized cable assembly
OZHB10 10lbs. headache ball
Davit crane, headache ball, and cable assemblies sold separately.
Locking collar included with applicable wheel base kits.

Features

- Industrial strength steel construction with a durable powder-coat finish
- Patent-pending floor-anchoring system allows the davit to rotate while under load (when base is not anchored the davit must remain in a forward position when lifting)
- Durable polyurethane-tread indoor/outdoor wheels with rear swivel casters, ensuring smooth mobility and adaptability to various workspaces. Rear casters feature a lock brake for enhanced safety and stability when needed.
- Forklift pockets (for transporting only)

Includes

Floor-Anchor Mounting Bolt Kit: Enhance the stability and safety of your OZ Wheel Base with optional floor-anchoring bolts, ensuring secure attachment to the ground for added peace of mind during operation. Includes four (4) 12" zinc-plated hex head bolts and washers. *Concrete anchor not included.*

Davit Crane Locking Collar: This component effectively prevents the crane boom from rotating excessively, eliminating the risk of tipping hazards and ensuring a secure lifting environment. *Included with models OZWB1, OZWB1-TP, OZWB2, OZWB2-TP, and OZWB3.*

Toolbox Storage Tube: Keep your tools and Wheel Base accessories organized with this durable and versatile toolbox storage tube, molded from high-density polypropylene and featuring a secure screw-cap and latch closure for secure storage. Zip ties are included for convenient, versatile mounting.

**Davit crane sold separately*

- OZWB** Wheel Base for OZ Lifting Products davit cranes up to 1200 lbs. capacity (pedestal base and locking collar not included)
- OZWB1** Wheel Base for use with OZ1200DAV davit crane (pedestal base and locking collar included)
- OZWB1-TP** Wheel Base for use with OZTP1200DAV, OZA1000DAV, OZXR1000DAV davit cranes (pedestal base and locking collar included)
- OZWB2** Wheel Base for use with OZ1000DAV and OZCF1200DAV davit cranes (pedestal base and locking collar included)
- OZWB2-TP** Wheel Base for use with OZTP500DAV davit crane (pedestal base and locking collar included)
- OZWB3** Wheel Base for use with OZ500DAV, OZA500DAV and OZXR500DAV davit cranes (pedestal base and locking collar included)

Patent-Pending Floor-Anchoring System with Locking Collar



OZWB DIMENSIONS

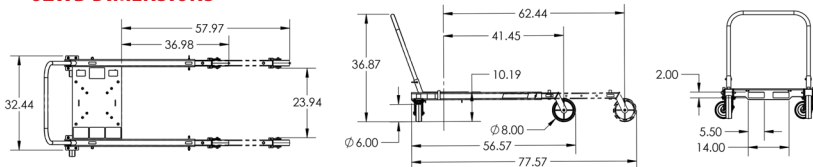

ADJUSTABLE LEG EXTENSIONS

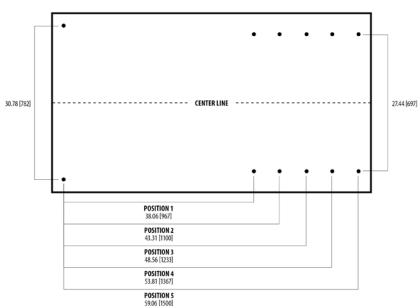

FLOOR-ANCHORING SYSTEM

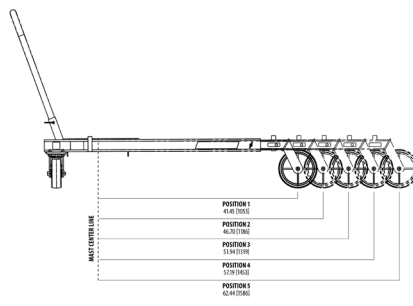

OZWB DAVIT CRANE REACH DIAMETER

Sections are representative of hook reach in 360-degrees

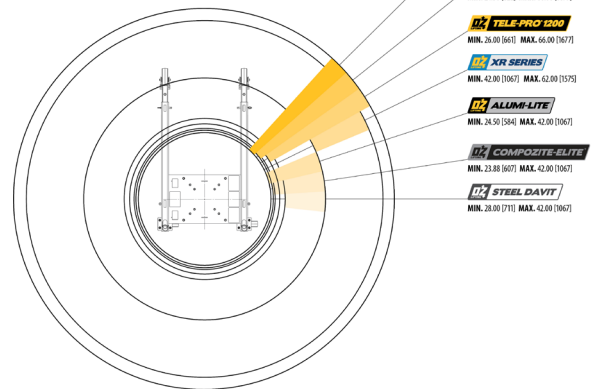

Diagram dimensional values are provided in inches. Bracketed values [] within diagram represent equivalent measurements in millimeters for informational purposes only. Dimensions and illustrations are for reference only and subject to change without notice.



WIRE/SYNTHETIC ROPE ASSEMBLIES

Steel Wire Rope (For manual winch)

OZGAL.19-80B	3/16" x 80'	Galvanized cable assembly
OZSS.19-80B	3/16" x 80'	Stainless steel cable assembly
OZGAL.25-55B	1/4" x 55'	Galvanized cable assembly
OZSS.25-55B	1/4" x 55'	Stainless steel cable assembly

Above cable assemblies come with swaged ball and swivel hook with latch.

Custom cable length available.

3/16" - 80 ft. max. length • 1/4" - 55 ft. max. length

Steel Wire Rope (For manual and power winch)

OZGAL.19-90	3/16" x 90'	Galvanized cable assembly
OZSS.19-90	3/16" x 90'	Stainless Steel cable assembly
OZGAL.25-45	1/4" x 45'	Galvanized cable assembly
OZSS.25-45	1/4" x 45'	Stainless Steel cable assembly

All cable assemblies come with a swivel hook with latch.

Custom cable length available.

3/16" - 90 ft. max. length • 1/4" - 45 ft. max. length



Synthetic Rope

OZSR.19-15	3/16" x 15'	Synthetic Rope
OZSR.19-50	3/16" x 50'	Synthetic Rope
OZSR.19-90	3/16" x 90'	Synthetic Rope
OZSR.25-50	1/4" x 50'	Synthetic Rope
OZSR.25-75	1/4" x 75'	Synthetic Rope
OZSR.31-45	5/16" x 45'	Synthetic Rope

All synthetic rope assemblies come with looped ends and pre-installed swivel hook with latch





HEADACHE BALL

OZHB10

Keeps your wire rope tensioned even when lowering the hook with no load. Compatible with 3/16" and 1/4" wire rope assemblies. Headache balls sold separately from all davit cranes and wire rope assemblies.



DAVIT CRANE COVER

OZDAV-C1

Protect your davit crane from the elements with this waterproof cover. Compatible with all OZ Lifting Products davit cranes 1200 lbs. capacity or less excluding the XR series.



DAVIT CRANE ROLLER BAG

OZRB1

Store and transport your davit crane in this davit crane roller bag. Fits OZ Lifting Products davit crane models OZ500DAV, OZ1000DAV, OZ1200DAV, OZCF1200DAV, OZA500DAV, & OZA1000DAV.

