

# STEEL DAVIT CRANE

Individually tested and certified at 125% W.L.L

OZ500DAV, OZ1000DAV, OZ2500DAV



**500 lb., 1000 lb. and 2500 lb. Capacity**

## Features

- 360 degree rotation
- 4 different boom height adjustments
- 500, 1000, and 2500 lb. ratings available
- Manual Din rated CE winch with brake (Includes power drill adapter)
- Corrosion Resistant Zinc plated finish
- Headache Ball (OZHB10) available and sold separately
- Carrying case (OZRB1) available and sold separately

OZ1000DAV shown with optional OZPED2 Pedestal base and OZGAL.25-55B wire rope assembly  
Bases and cable assemblies sold separately

## WIRE/SYNTHETIC ROPE ASSEMBLIES

(sold separately) Custom length available.  
See wire/synthetic rope assembly options page 39

### OZ500DAV & OZ1000DAV

Manual winch: 3/16" - 80 ft max. lift length • 1/4" - 55ft max. lift length  
AC/DC Electric Winch: 3/16" - 90 ft max. lift length • 1/4" - 45ft max. lift length

### OZ2500DAV

Manual winch: 1/4" Synthetic - 75 ft max. lift length • 5/16" Synthetic - 55ft max. lift length • 3/8" Synthetic - 45ft max. lift length

## Options for faster lowering and raising

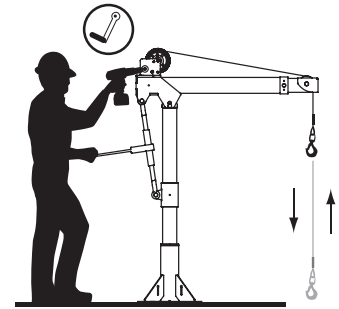

Detach winch handle for drill option

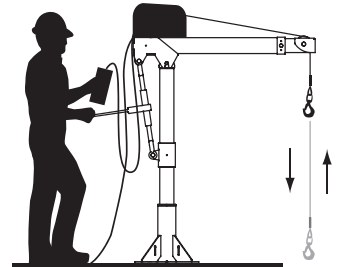

AC and DC power winches available  
See page 26

## Weight

Weight (excluding winch)	Boom	Mast	Net
OZ500DAV (lb.)	27	23	50
OZ1000DAV (lb.)	35	29	64
OZ2500DAV (lb.)	130	64	194

## OZ500DAV DIMENSIONS

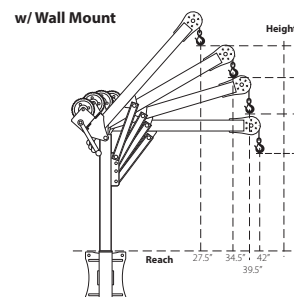
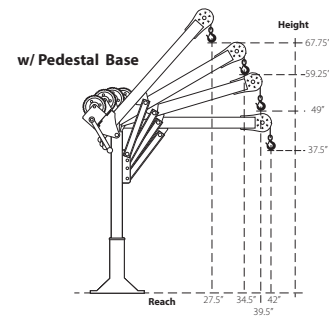
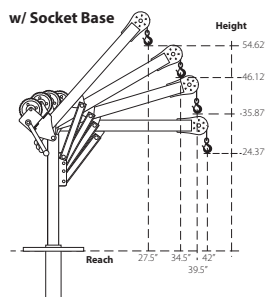

## Load Ratings

\*OZ500DAV based on 3/16" or 5/16" wire & synthetic rope

All Positions	
First Layer	500 lb.
Mid Drum	500 lb.
Full Drum	500 lb.

## OZ500DAV BASES (sold separately) Comes with mounting template.

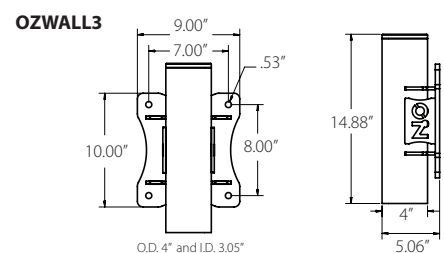
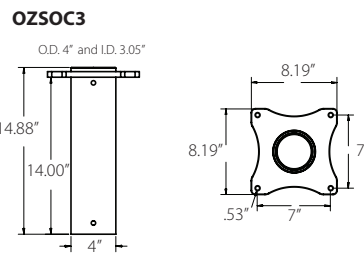
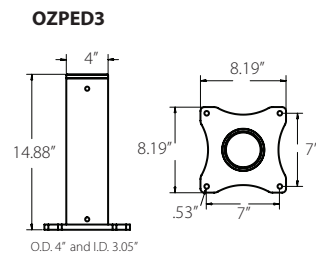

Davit crane maintains maximum capacity in all positions. However, the listed load rating reflects manual winch operation, assuming average lifting effort. Handle effort will increase as the cable is spooled onto the drum. Load rating and ease of lifting depend on the specific winch style and the user's lifting effort. Dimensions and illustrations are for reference only and subject to change without notice.



**WARNING**  
CANCER AND REPRODUCTIVE HARM  
Some products may contain chemicals known to the state of California to cause cancer, or birth defect or reproductive harm.  
www.P65Warning.ca.gov



### OZ1000DAV DIMENSIONS

w/ Socket Base

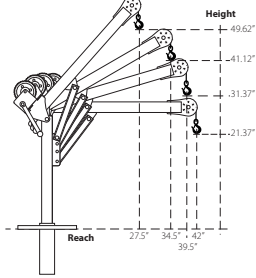

w/ Pedestal Base

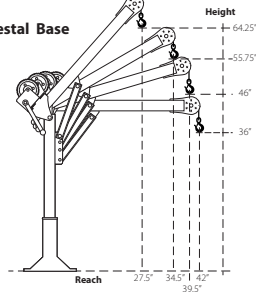

w/ Wall Mount

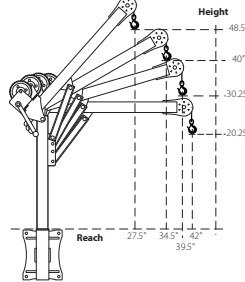

### Load Ratings

\*OZ1000DAV based on 1/4" wire & 3/16" synthetic rope

All Positions	
First Layer	1000 lb.
Mid Drum	875 lb.
Full Drum	550 lb.

OZ1000DAV BASES (sold separately) \*Base inside diameter 3.0" • Comes with mounting template.

OZPED2

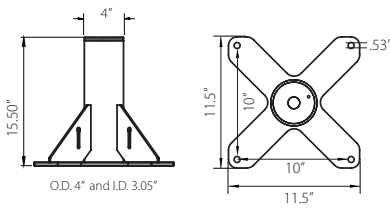

OZSOC2

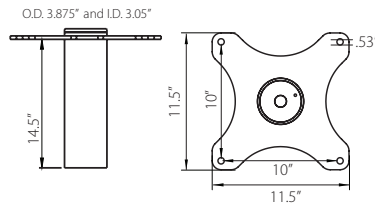

OZWALL2

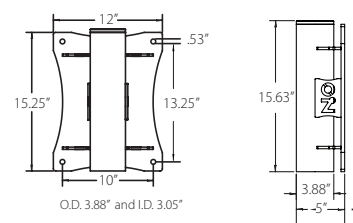

### OZ2500DAV DIMENSIONS

w/ Socket Base

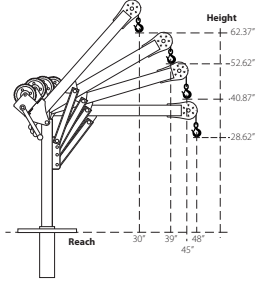

w/ Pedestal Base

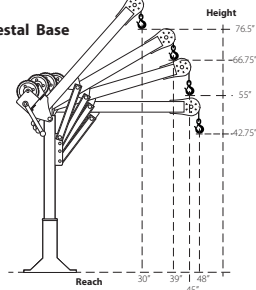

w/ Wall Mount

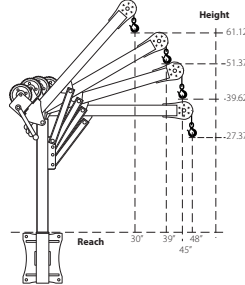

### Load Ratings

\*OZ2500DAV based on 3/8" synthetic rope

All Positions	
First Layer	2500 lb.
Mid Drum	2000 lb.
Full Drum	1550 lb.

OZ2500DAV BASES (sold separately) \*Base inside diameter 4.5" • Comes with mounting template.

OZPED4

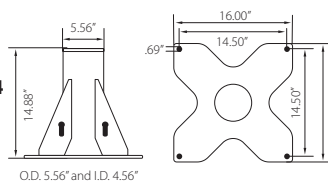

OZSOC4

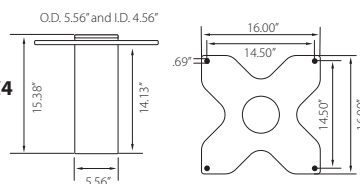

OZWALL4

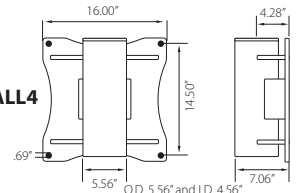

Davit crane maintains maximum capacity in all positions. However, the listed load rating reflects manual winch operation, assuming average lifting effort. Handle effort will increase as the cable is spooled onto the drum. Load rating and ease of lifting depend on the specific winch style and the user's lifting effort. Dimensions and illustrations are for reference only and subject to change without notice.

# WHEEL BASE

For all OZ Lifting Products davit cranes up to 1200 lb. capacity



OZWB3 shown with OZXR500  
OZGAL.19-80B galvanized cable assembly  
OZHB10 10lb. headache ball  
Davit crane, headache ball, and cable assemblies sold separately.  
Locking collar included with applicable wheel base kits.

## Features

- Industrial strength steel construction with a durable powder-coat finish
- Patent-pending floor-anchoring system allows the davit to rotate while under load (when base is not anchored the davit must remain in a forward position when lifting)
- Durable polyurethane-tread indoor/outdoor wheels with rear swivel casters, ensuring smooth mobility and adaptability to various workspaces. Rear casters feature a lock brake for enhanced safety and stability when needed.
- Forklift pockets (for transporting only)

## Includes

**Floor-Anchor Mounting Bolt Kit:** Enhance the stability and safety of your OZ Wheel Base with optional floor-anchoring bolts, ensuring secure attachment to the ground for added peace of mind during operation. Includes four (4) 12" zinc-plated hex head bolts and washers. *Concrete anchor not included.*

**Davit Crane Locking Collar:** This component effectively prevents the crane boom from rotating excessively, eliminating the risk of tipping hazards and ensuring a secure lifting environment. *Included with models OZWB1, OZWB1-TP, OZWB2, OZWB2-TP, and OZWB3.*

**Toolbox Storage Tube:** Keep your tools and Wheel Base accessories organized with this durable and versatile toolbox storage tube, molded from high-density polypropylene and featuring a secure screw-cap and latch closure for secure storage. Zip ties are included for convenient, versatile mounting.

*\*Davit crane sold separately*

- OZWB** Wheel Base for OZ Lifting Products davit cranes up to 1200 lb. capacity (pedestal base and locking collar not included)
- OZWB1** Wheel Base for use with OZ1200DAV davit crane (pedestal base and locking collar included)
- OZWB1-TP** Wheel Base for use with OZTP1200DAV, OZA1000DAV, OZXR1000DAV davit cranes (pedestal base and locking collar included)
- OZWB2** Wheel Base for use with OZ1000DAV and OZCF1200DAV davit cranes (pedestal base and locking collar included)
- OZWB2-TP** Wheel Base for use with OZTP500DAV davit crane (pedestal base and locking collar included)
- OZWB3** Wheel Base for use with OZ500DAV, OZA500DAV and OZXR500DAV davit cranes (pedestal base and locking collar included)

## Patent-Pending Floor-Anchoring System with Locking Collar



## OZWB DIMENSIONS

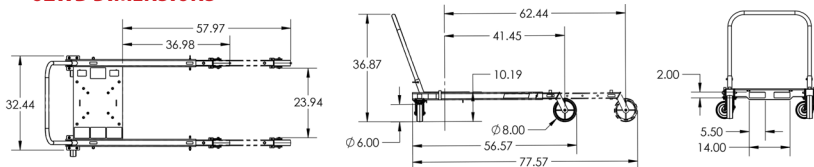

## ADJUSTABLE LEG EXTENSIONS

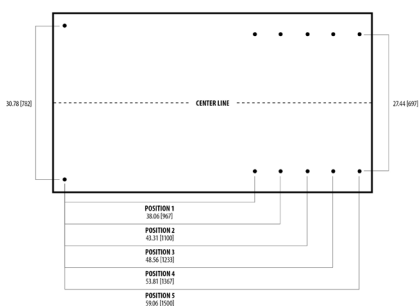

## FLOOR-ANCHORING SYSTEM

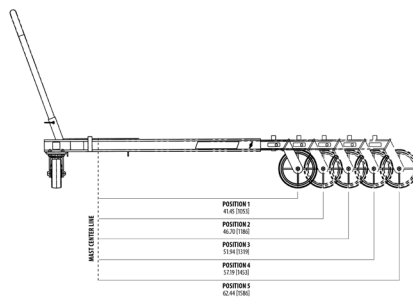

## OZWB DAVIT CRANE REACH DIAMETER

Sections are representative of hook reach in 360-degrees

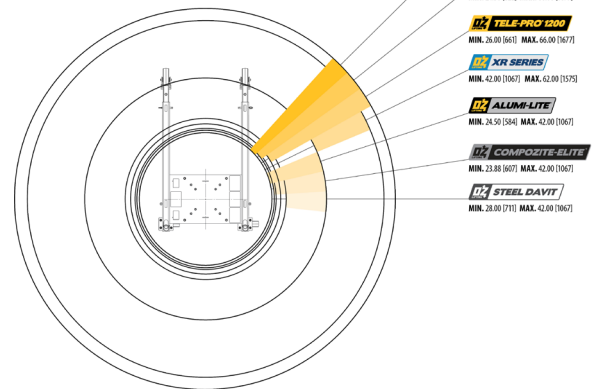

Diagram dimensional values are provided in inches. Bracketed values [ ] within diagram represent equivalent measurements in millimeters for informational purposes only. Dimensions and illustrations are for reference only and subject to change without notice.



# WIRE/SYNTHETIC ROPE ASSEMBLIES

## Steel Wire Rope (For manual winch)

OZGAL.19-80B	3/16" x 80'	Galvanized cable assembly
OZSS.19-80B	3/16" x 80'	Stainless steel cable assembly
OZGAL.25-55B	1/4" x 55'	Galvanized cable assembly
OZSS.25-55B	1/4" x 55'	Stainless steel cable assembly

Above cable assemblies come with swaged ball and swivel hook with latch.

**Custom cable length available.**

3/16" - 80 ft. max. length • 1/4" - 55 ft. max. length

## Steel Wire Rope (For manual and power winch)

OZGAL.19-90	3/16" x 90'	Galvanized cable assembly
OZSS.19-90	3/16" x 90'	Stainless steel cable assembly
OZGAL.25-45	1/4" x 45'	Galvanized cable assembly
OZSS.25-45	1/4" x 45'	Stainless Steel cable assembly

All cable assemblies come with a swivel hook with latch.

**Custom cable length available.**

3/16" - 90 ft. max. length • 1/4" - 45 ft. max. length

## Synthetic Rope

OZSR.19-15	3/16" x 15'	Synthetic Rope
OZSR.19-50	3/16" x 50'	Synthetic Rope
OZSR.19-90	3/16" x 90'	Synthetic Rope
OZSR.25-50	1/4" x 50'	Synthetic Rope
OZSR.25-75	1/4" x 75'	Synthetic Rope
OZSR.31-45	5/16" x 45'	Synthetic Rope

All synthetic rope assemblies come with looped ends and pre-installed swivel hook with latch



## HEADACHE BALL

OZHB10

Keeps your wire rope tensioned even when lowering the hook with no load. Compatible with 3/16" and 1/4" wire rope assemblies. Headache balls sold separately from all davit cranes and wire rope assemblies.



## WIRE ROPE HOLDER

OZWRH

Secure your davit crane's wire rope with our durable and easy-to-use wire rope holder. For use with 3/16" and 1/4" ball end wire rope.



## WINCH COVER

OZECW



This weatherproof winch cover provides additional protection, keeping your electric winch clean, dry, and looking new. It is specially treated for cold weather use and is made from strong, water-resistant, black vinyl, featuring drawstring for quick closure and cable opening for easy installation. Made in the USA.







## DAVIT CRANE COVER

OZDAV-C1

Protect your davit crane from the elements with this waterproof cover. Compatible with all OZ Lifting Products davit cranes 1200 lb. capacity or less excluding the XR series.



## DAVIT CRANE MAST EXTENSION

OZEXT1-COMP, OZEXT1-TP, OZEXT2, OZEXT2-TP

Increase the height of your davit crane with our durable and easy-to-install mast extender. This extender is made of high-strength steel and is available in a variety of lengths to fit most davit cranes. Add 24 inches of additional height to your davit crane with this simple and effective solution.



## DAVIT CRANE LOCKING COLLAR

TP500-LC, TP1200-LC, SCF-LC

Keep your davit crane secure and prevent accidental rotation with our durable and easy-to-use locking collar.



## DAVIT CRANE ROLLER BAG

OZRB1

The OZ Lifting Products davit crane roller bag is a durable and convenient way to transport and protect your davit crane. Made of heavy-duty nylon, the bag features a padded interior and reinforced straps to keep your crane safe from scratches and dings. Plus, the convenient roller wheels make it easy to move your crane around. The bag also has a large capacity, so you can easily fit all of your crane's accessories inside.

